

SP-500 Strong point for escort towing

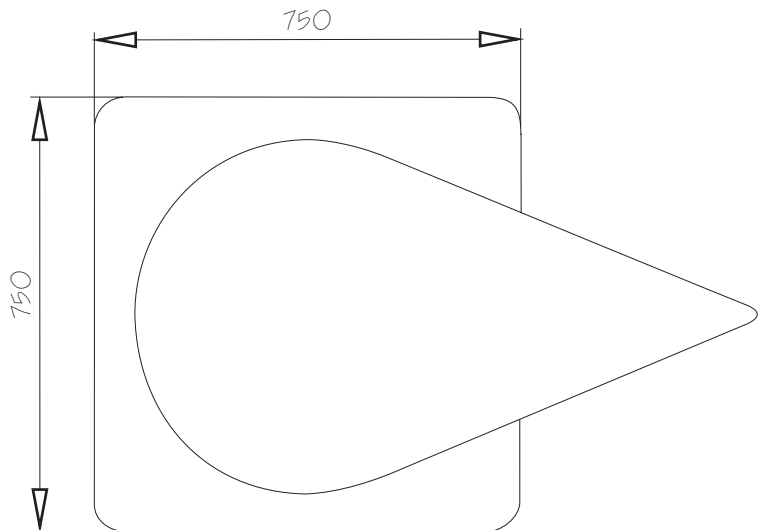
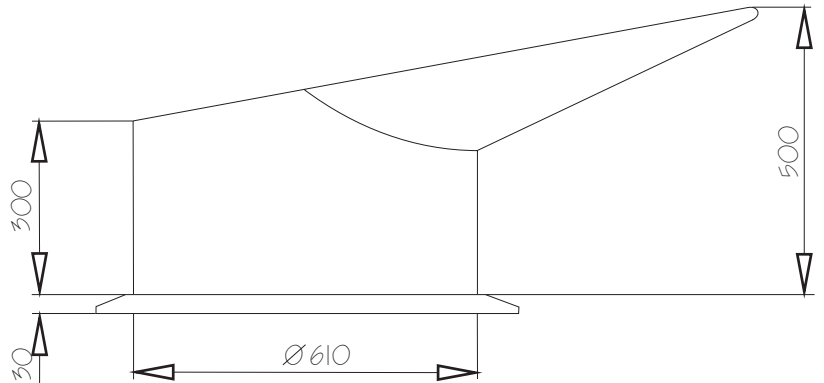
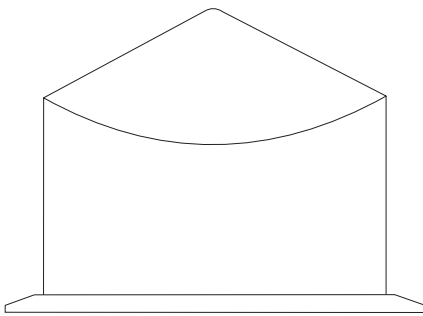

Product Information

Materia: S355J2G3

Dimension: 750X750X500 mm

SWL: 200 T

MBL: 400 T

Weight: 270 kg.



Type Approved Product MBL 200 tonnes and SWL 100 tonnes.

www.safetybitt.com